

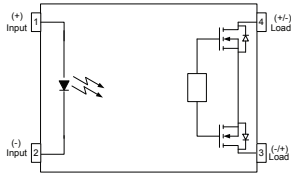

| Parameter           | Symbol     | Rating | Units   |
|---------------------|------------|--------|---------|
| Load Voltage        | $V_L$      | 1800   | V       |
| Load Current        | $I_L$      | 0.030  | A       |
| Leakage Current     | $I_{Leak}$ | 0.1    | $\mu A$ |
| Low Out Capacitance | $C_{out}$  | 8      | pF      |

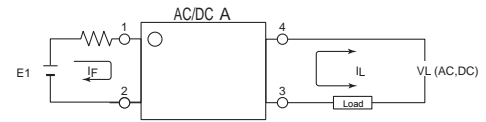

AC/DC Type  
 (1) Input: DC +  
 (2) Input: DC -  
 (3) Output: DC or AC  
 (4) Output: DC or AC



## APSEMI PhotoRelays

APSEMI Photorelays are the most reliable, technically advanced logic-to-power interface devices. Their basic function is to take a low current signal from a microprocessor to control the switching of both AC and DC loads, while providing an isolation barrier between logic and power.

While this function is common to all relays, Photorelays provide distinct advantages over their mechanical counterparts including:

- Long life (No limit on mechanical and electrical lifetime)
- Bounce-free switching
- Higher speed and high frequency switching
- Higher sensitivity (less power consumption)
- Immunity to EMI or RFI
- No have voltaic arc, bounce, and noise
- More resistant to vibration and impact
- AC or DC load switching
- Small package size

## Applications

These advantages make APSEMI Photorelays the ideal choice for:

- Telecom/Datacom switching
- Multiplexers
- Meter reading systems
- Data acquisition
- Medical equipment
- Battery monitoring
- I/O Sub-Systems
- Robotics
- Aerospace
- Home/Safety security systems
- Process Control
- Energy Management
- Reed Relay EMR Replacement
- Programmable Controllers

## TPYES

| Category | Output Rating |              | Package | Part No. | Packing Quantity               |
|----------|---------------|--------------|---------|----------|--------------------------------|
|          | Load Voltage  | Load Current |         |          |                                |
| AC/DC    | 1800V         | 30mA         | WDIP-4  | APV278WE | 50pcs /tube<br>500pcs /Package |

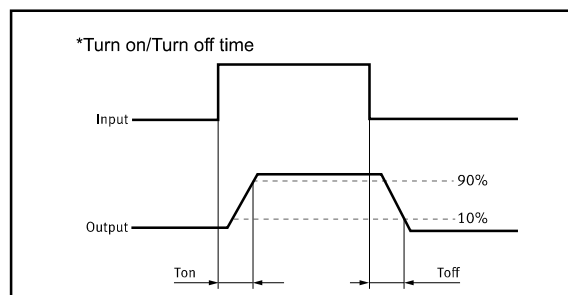



### Absolute Maximum Ratings (Ta = 25°C)

| Item                      |                          | Symbol     | Value      | Units            | Note                |
|---------------------------|--------------------------|------------|------------|------------------|---------------------|
| Input                     | Continuous LED Current   | $I_F$      | 50         | mA               |                     |
|                           | Peak LED Current         | $I_{FP}$   | 1000       | mA               | f=100Hz,<br>duty=1% |
|                           | LED Reverse Voltage      | $V_R$      | 5          | V                |                     |
|                           | Input Power Dissipation  | $P_{In}$   | 75         | mW               |                     |
| Output                    | Load Voltage             | $V_L$      | 1800       | V(AC peak or DC) |                     |
|                           | Load Current             | $I_L$      | 30         | mA               |                     |
|                           | Peak Load Current        | $I_{Peak}$ | 150        | mA               | 100ms(1 pulse)      |
|                           | Output Power Dissipation | $P_{out}$  | 450        | mW               |                     |
| Total Power Dissipation   |                          | $P_T$      | 500        | mW               |                     |
| I/O Breakdown Voltage     |                          | $V_{I/O}$  | 5000       | Vrms             | RH=60%, 1min        |
| Operating Temperature     |                          | $T_{opr}$  | -40 to 85  | °C               |                     |
| Storage Temperature       |                          | $T_{stg}$  | -40 to 100 | °C               |                     |
| Pin Soldering Temperature |                          | $T_{sol}$  | 260        | °C               | 10 sec max.         |

### Electrical Characteristics (Ta = 25°C)

| Item             |                           | Symbol     | MIN.      | TYP. | MAX. | Units    | Conditions  |
|------------------|---------------------------|------------|-----------|------|------|----------|---|
| Input            | LED Forward Voltage       | $V_F$      |           | 1.33 | 1.5  | V        | $I_F=10mA$  |
|                  | Operation LED Current     | $I_{Fon}$  |           | 2.0  | 5.0  | mA       |   |
|                  | Recovery LED Current      | $I_{Foff}$ |           | 0.35 | 0.8  | mA       |   |
|                  | Recovery LED Voltage      | $V_{Foff}$ | 0.7       |      |      | V        |   |
| Output           | On-Resistance             | $R_{on}$   | 120       | 200  | 260  | $\Omega$ | $I_F=10mA, I_L=$ Rating,<br>Time to flow is within 1 sec. |
|                  | Off-State Leakage Current | $I_{Leak}$ | 0.01      | 0.02 | 0.1  | $\mu A$  | $V_L=$ Rating   |
|                  | Output Capacitance        | $C_{out}$  |           | 8    |      | pF       | $V_L=0, f=1MHz$   |
| Transmis<br>sion | Turn-On Time              | $T_{on}$   |           | 0.08 | 0.1  | ms       | $I_F=10mA, I_L=$ Rating                                   |
|                  | Turn-Off Time             | $T_{off}$  |           | 0.05 | 0.1  | ms       |   |
| Coupled          | I/O Isolation Resistance  | $R_{I/O}$  | $10^{10}$ |      |      | $\Omega$ | DC500V  |
|                  | I/O Capacitance           | $C_{I/O}$  |           | 0.8  | 1.3  | pF       | f=1MHz  |

Please obey the following conditions to ensure proper device operation and resetting. Input LED current (Recommended value):  $I_F \geq 5mA$  and  $\leq 30mA$



## Reference Data

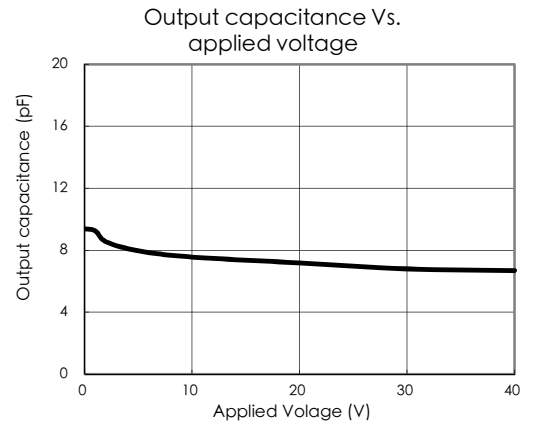
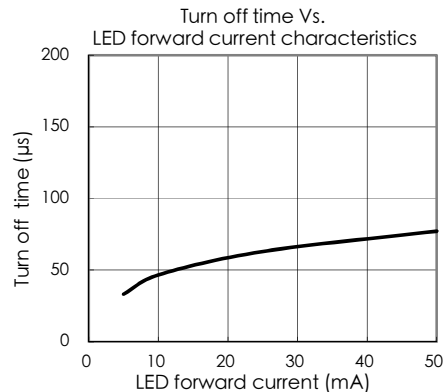
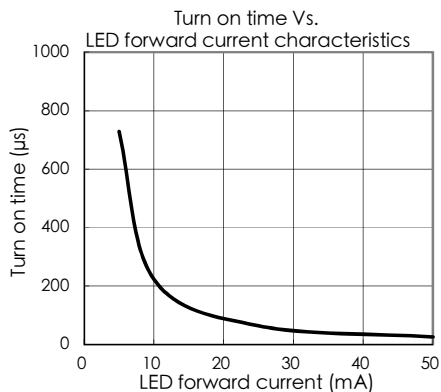
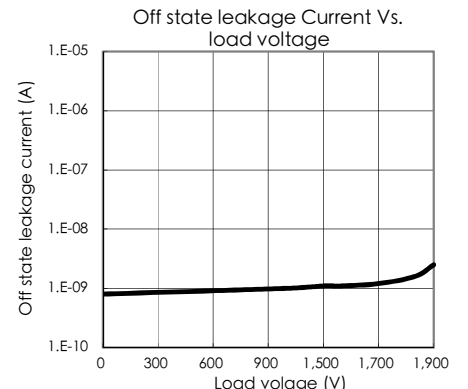
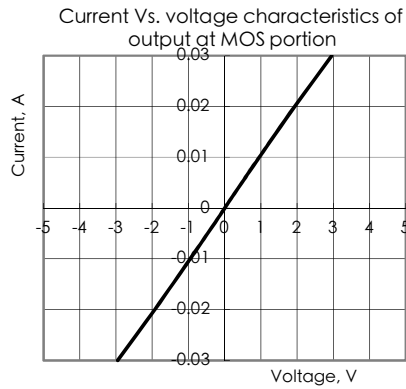
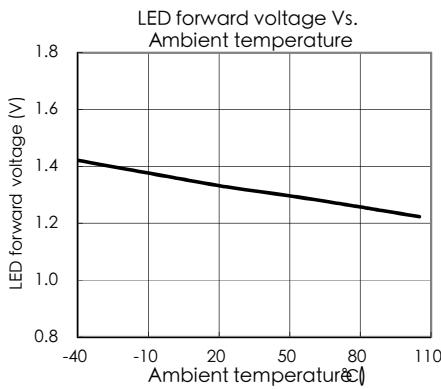
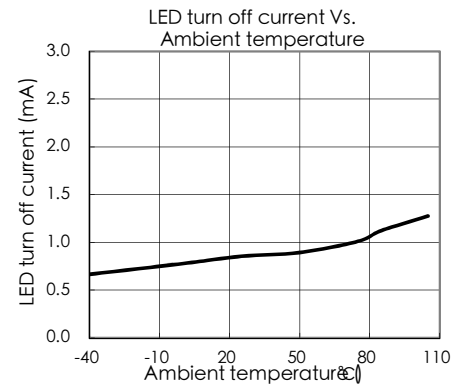
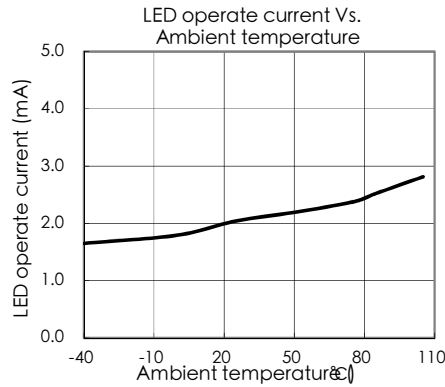
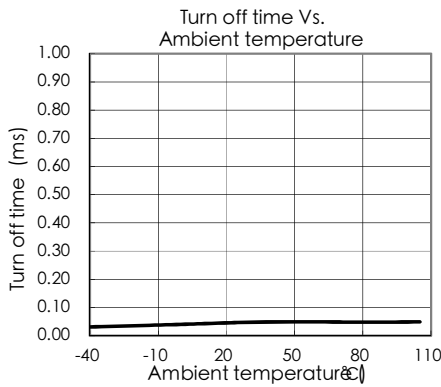
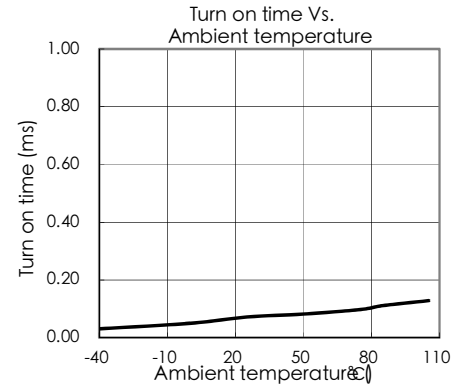
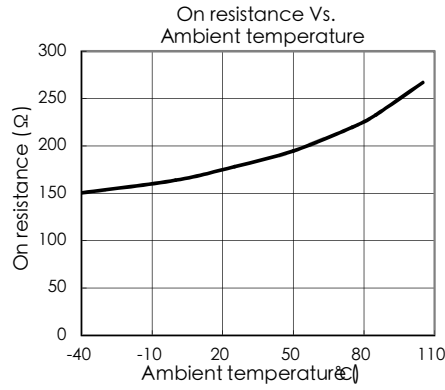
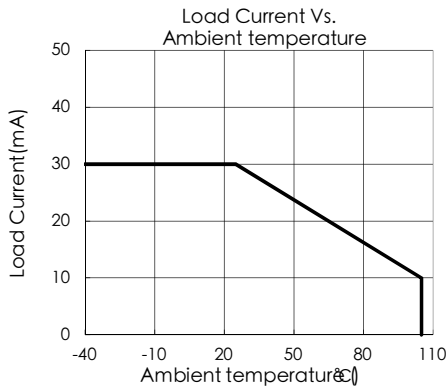



## Marking and Label

### Marking

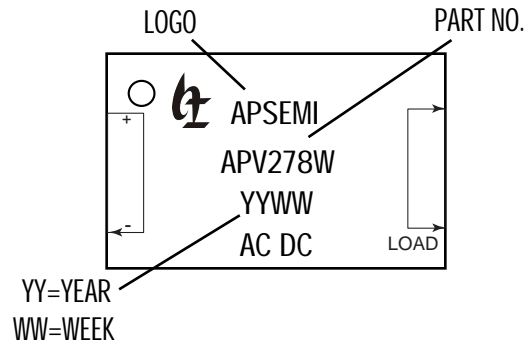

### Label



## DIP Tape dimensions Unit : mm

Devices are packaged in a tube so that pin No. 1 is on the stopper B side. Observe correct orientation when mounting them on PC boards.

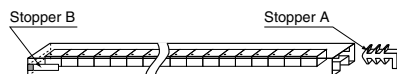



### Dimensions and DIP-5 Package Unit: mm

Through hole terminal type

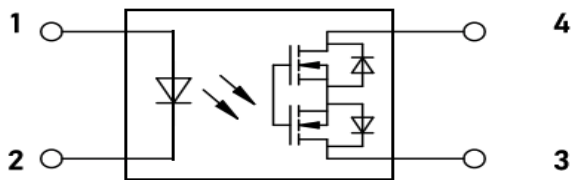
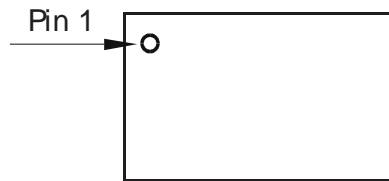
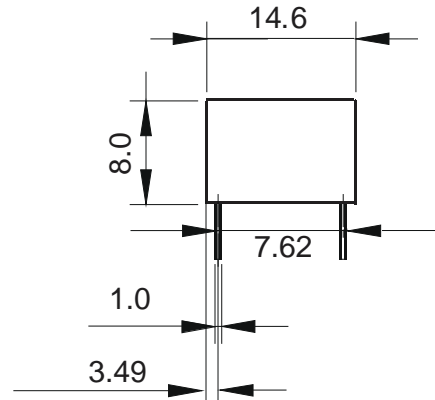
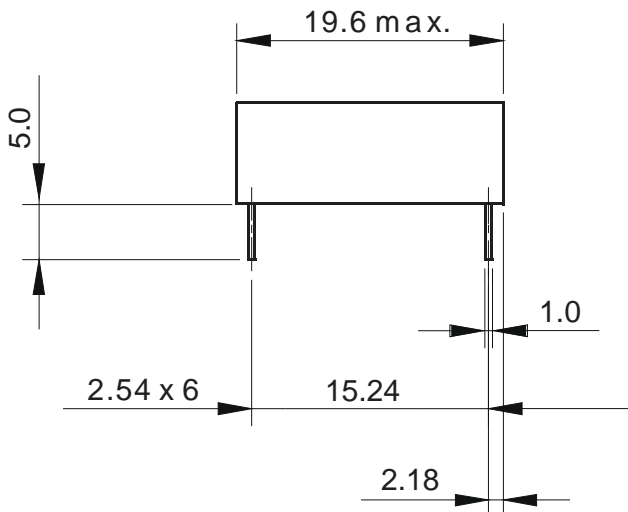

AC/DC Type

- (1) Input: DC +
- (2) Input: DC -
- (3) Output: DC or AC
- (4) Output: DC or AC

PC board pattern (Bottom view)

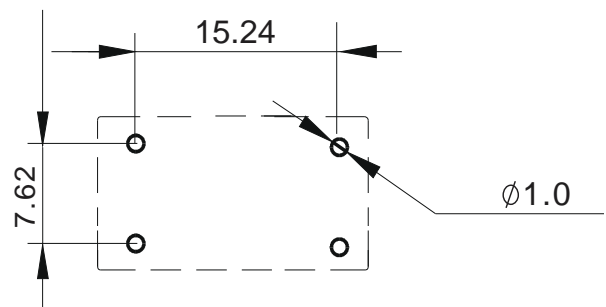



## Using Methods

Examples of resistance value to control LED forward current ( $I_F=5\text{mA}$ )

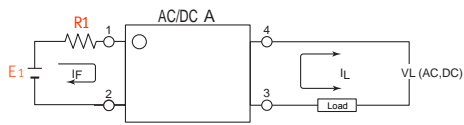

| E1   | R1 (Approx)   |
|------|---------------|
| 3.3V | 300 $\Omega$  |
| 5.0V | 600 $\Omega$  |
| 12V  | 1.9K $\Omega$ |
| 24V  | 4.1K $\Omega$ |

LED forward current must be more than 5mA , at I(MIN) ,and less than 30mA , at I(MAX).

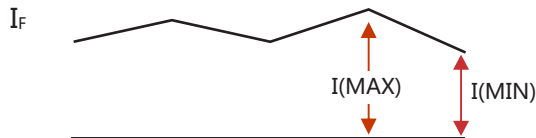

## Recommended Operating Conditions

Please obey the following conditions to ensure proper device operation and resetting. Input LED current (Recommended value):

| Characteristic  | Symbol | Min | Typ. | Max | Unit |
|-----------------|--------|-----|------|-----|------|
| Forward current | $I_F$  | 5.0 | 7.0  | 30  | mA   |

## Protection Circuit

Clamp diode is connected in parallel with the load.  
Absorb capacity with external diode.

CR Snubber is connected in parallel with the load.  
Absorb capacity with buffer capacity.

When adding diodes, buffer circuits (C-R), and other protections, they need to be installed near the MOS RELAY to be effective. Adding protection elements may result in a slow reset time, so adjust them according to the actual situation before use.

Note: When developing designs using this product, perform the expected performance of the equipment under the operating conditions recommended by the guidelines in this document. Continuous use under heavy loads (including, but not limited to, the application of high temperatures/current/voltage and significant changes in temperature, etc.) may result in deterioration of the reliability of this product.



## RESTRICTIONS ON PRODUCT USE

---

APSEMI Co. and its subsidiaries and affiliates (collectively "APSEMI") reserve the right to make changes to all information contained in this document relating to hardware, software, and systems (collectively "Products").

No information in this document may be reproduced without the prior written permission of APSEMI. Even with APSEMI's written permission, this document may only be reproduced if it is guaranteed to be unaltered or missing.

APSEMI assumes no responsibility for unintended uses of the product:

Unintended uses include, but are not limited to, equipment used in nuclear facilities, equipment used in the aerospace industry, medical equipment, automobiles, trains, ships, and other transportation equipment, traffic signaling equipment, equipment used for the control of combustion or explosions, safety devices, elevators and escalators, equipment used in electrical power-related applications, and equipment used in financial-related applications.

APSEMI assumes no responsibility for the product if you use it for any purpose other than the specific purpose described in this document.

- The information contained herein is provided only as a guide for the use of the product. APSEMI assumes no responsibility for infringement of third party patents or any other intellectual property rights that may result from the use of the product. This document does not grant any license, express or implied, estoppel or otherwise, to any intellectual property.

- GaAs (Gallium Arsenide) is used in products and is harmful to humans. Inadvertent ingestion or absorption of GaAs can harm the human body, so handle the product with care and do not break, cut, crush, grind, chemically dissolve, or otherwise expose GaAs in the product.

- Please be aware of environmental issues and use products in compliance with all applicable laws and regulations governing the inclusion or use of controlled substances, including but not limited to the EU RoHS Directive. APSEMI assumes no responsibility for damages or losses resulting from non-compliance with applicable laws and regulations.